

XPC10

High temperature miniature pressure sensor

SPECIFICATIONS

- Ranges 10 to 500 bar [150 to 7 500 psi]
- Absolute, sealed and gauge
- High temp. from -40 up to 220 °C [-40 to 428 °F]
- Stainless steel construction
- For static and dynamic applications
- Linearity up to ±0.25% F.S.

FEATURES

- Low Installation Torque Sensitivity
- M10x1 or 3/8-24UNF thread
- Specific threads lengths on request
- Integrated Amplifier optional
- Titanium body on request
- Optional IP67 Ingress Protection

APPLICATIONS

- Aerospace
- Test benches
- Oven monitoring equipment
- Cooling regulation systems

The **XPC10** is a miniature pressure transducer specifically designed to measure static and dynamic pressures in temperatures from -40 to 220 °C [-40 °F to 428 °F] (unamplified models).

Made of stainless steel, the rugged **XPC10** is suitable for corrosive liquids and gases in a wide variety of harsh environments.

The **XPM10** threaded construction virtually eliminates zero shifts caused by installation torque.

The core technology of the **XPC10** consists of a foil strain gage wired in a Wheatstone bridge circuit to provide excellent temperature stability. An on-board amplifier is optionally available.

A **PT1000** temperature probe is optionally available for all ranges as a custom design.

On request, Instruction documents can be provided to ease the selection and use of our sensors and provide helpful tips.

XPC10

High temperature miniature pressure sensor

STANDARD RANGES

Ranges (FS)		Pressure Reference			Resonance Frequency ¹²	Sensitivity "FSO" ³ (non amplified)	Overpressure (rated pressure)	Burst Pressure (rated pressure)
bar	psi	Gauge	Abso.	Sealed				
10 ¹	150 ¹	•	•	•	34 kHz	1.2 mV/V	1.5 x FS	3 x FS
20	300	•	•	•	50 kHz	1.2 mV/V	1.5 x FS	3 x FS
35	500	•	•	•	70 kHz	1.2 mV/V	1.5 x FS	3 x FS
50	750	•	•	•	80kHz	1.2 mV/V	1.5 x FS	3 x FS
70	1K	•	•	•	95 kHz	1.2 mV/V	1.5 x FS	3 x FS
100	1.5K			•	110 kHz	1.2 mV/V	1.5 x FS	3 x FS
200	3K			•	155 kHz	1.2 mV/V	1.5 x FS	3 x FS
350	5K			•	220 kHz	1.2 mV/V	1.5 x FS	3 x FS
500	7.5K			•	250 kHz	1.2 mV/V	1.5 x FS	3 x FS

1. Lower pressure range 5 bar [75 psi] on request as custom design.
2. Useful frequency is 20% of Resonance Frequency. Bandwidth is 600Hz for all A1 amplified version.
3. Sensors are calibrated with 10Vdc power supply as standard.

PERFORMANCE SPECIFICATIONS (all values are typical at ambient temperature 23±3°C)

Parameters	Nonamplified ¹	A1	Notes
Power supply	1 to 10 Vdc regulated	10 to 30 Vdc	
Sensitivity "FSO"	See previous table	4 V ±0.2 V	Signal 0.5 - 4.5V for A1 option
Zero Offset	±1 mV	0.5 V ±0.2 V	
Combined Non-Linearity & Hysteresis	±0.5%FS ±0.3%FS ±0.25%FS		FS ≤ 10 bar 10 bar < FS < 100 bar 100 bar ≤ FS
Operating Temperature (OTR)	-40 to 220°C (-40 to 428°F)	-40°C to 120°C (-40°F to 250°F)	
Compensated Temperature (CTR)	0 to 150°C (32 to 300°F)	0 to 80°C (32°F to 170°F)	
Thermal Zero Shift in CTR (TZS)	< ±1%FS/50°C		
Thermal Sensitivity Shift in CTR (TSS)	< ±1% of reading /50°C		
Input Impedance or consumption	500 Ω nom.	< 50 mA	
Output Impedance	350 Ω nom.	1000 Ω	
Ingress Protection	IP50 IP67		Standard or SC option P7 option
Media – Pressure Port	Fluids compatible with stainless steel		

Insulation under 50Vdc ≥100MΩ

CE certification according to EN 61010-1, EN 50081-1, EN 50082-1.

XPC10

High temperature miniature pressure sensor

DIMENSIONS & WIRING SCHEMATIC

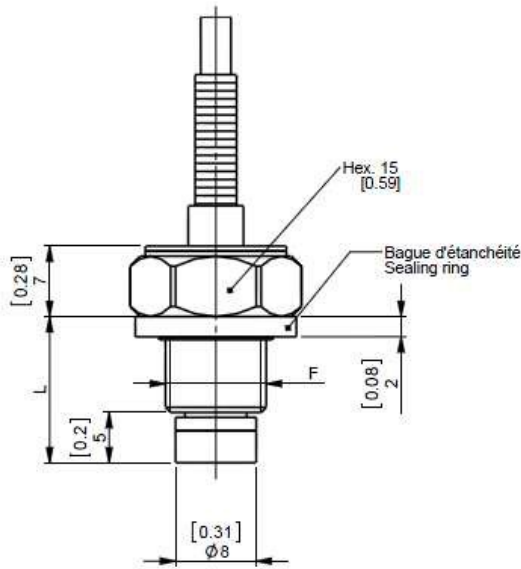

XPC10

Dimensions Metric & Imperial

	XPC10-M	XPC10-X
F (thread)	M10x1	3/8-24UNF
L (mm)	14.5	13.1
L (in)	[0.57]	[0.52]

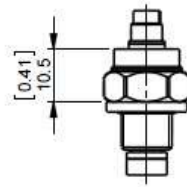

XPC10-*-SC

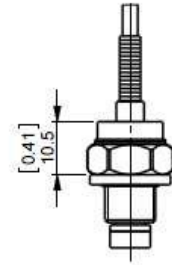

XPC10-*-A1

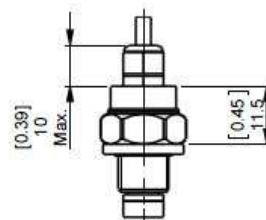

XPC10-*-P7

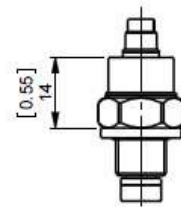

XPC10-*-A1-SC

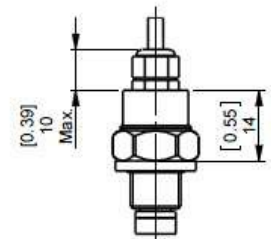

XPC10-*-A1-P7

WIRING AND CONNECTOR OPTION

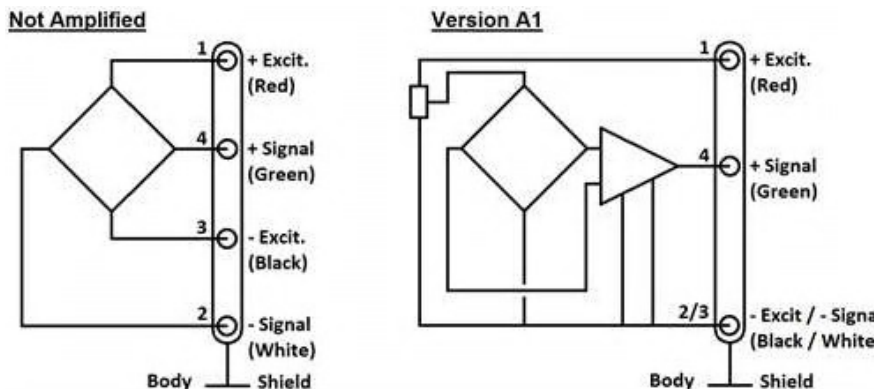

Notes:

1. Recommended Tightening Torque: 5 to 8 Nm (44 to 88 lbf.in)
2. Sealing: One Self-centred "FKM" sealing ring $\phi 16 \times 2$ is supplied with the sensor. Operating temperature is -30°C to 200°C [-20°F to 390°F] static; down to -40°C to 220°C [-40°F to 428°F] for short durations.
3. Electrical connection: Standard = 2m of shielded cable $\phi 3$ mm with 4 wires AWG30, Silicon jacket
 SC option = Integral connector ref. Comtronic CMR-02D-04P supplied with mating plug CMR-02-B-04S wired with 2m of cable (FMC-COM-4B-L2M)

XPC10

High temperature miniature pressure sensor

OPTIONS

ZI : Zero shift in CTR <0.75% F.S. / 50 °C [/100 °F]
Z02 : CTR -40 to 60 °C [-40 to 140 ° F]
Z35 : CTR 20 to 120 °C [70 to 250 ° F]
Z38 : CTR +20°C à +200°C [70 to 390°F] (not compatible with A1 and P7 option)
SC : Connector output, mating plug supplied with 2 m cable [6.6 ft]
P7 : IP67 protection / -20°C to +150°C [0°F to 300°F] (not compatible with gauge model)
V00 : Non-standard power supply calibration, replace "00" with value in Volt (standard 10Vdc, unamplified sensor only)
L00M : special cable length, replace "00" with total length in meters (standard length 2,0 m [6,6 ft])

ORDERING INFORMATION

XPC10	-	M	-	A1	-	20B	G	-	/L5M
Model	-	Mounting thread	-	Output signal	-	Pressure Range	Pressure reference	-	Options
XPC10		M : M10x1 X : 3/8-24UNF		(none) : bridge (mV) A1 : 0,5 to 4,5V		10B 20B 35B 50B 70B 100B 200B 350B 500B	150P 300P 500P 750P 1KP 1.5KP 3KP 5KP 7.5KP	A : absolute G : gauge S : sealed	ZI Z02 Z35 Z38 SC P7 L00M

Psi range models only supplied with imperial thread

Bar range models only supplied with metric thread.

The information given herein, including drawings, illustrations and schematics which are intended for illustration purposes only, is believed to be reliable. However, TE Connectivity makes no warranties as to its accuracy or completeness and disclaims any liability in connection with its use. TE Connectivity's obligations shall only be as set forth in TE Connectivity's Standard Terms and Conditions of Sale for this product and in no case will TE Connectivity be liable for any incidental, indirect or consequential damages arising out of the sale, resale, use or misuse of the product. Users of TE Connectivity products should make their own evaluation to determine the suitability of each such product for the specific application.